



Kyeam Technologies Co., Ltd.

# Corporate Profile Brief

FY2016/2017



## LIST OF CONTENTS

- General Information: Corporate Style
- A Message from the President
- Corporate Chronology
- Performance Certificates
- Organization Composition
- Fabrication
- Production Capacity
- Outsourced Supply
- Key Clientele
- [Appendix I: Corporate Performances](#)
- [Appendix II: Outsourced Literature](#)





# CORPORATE STYLE AND POINTS OF CONTACT

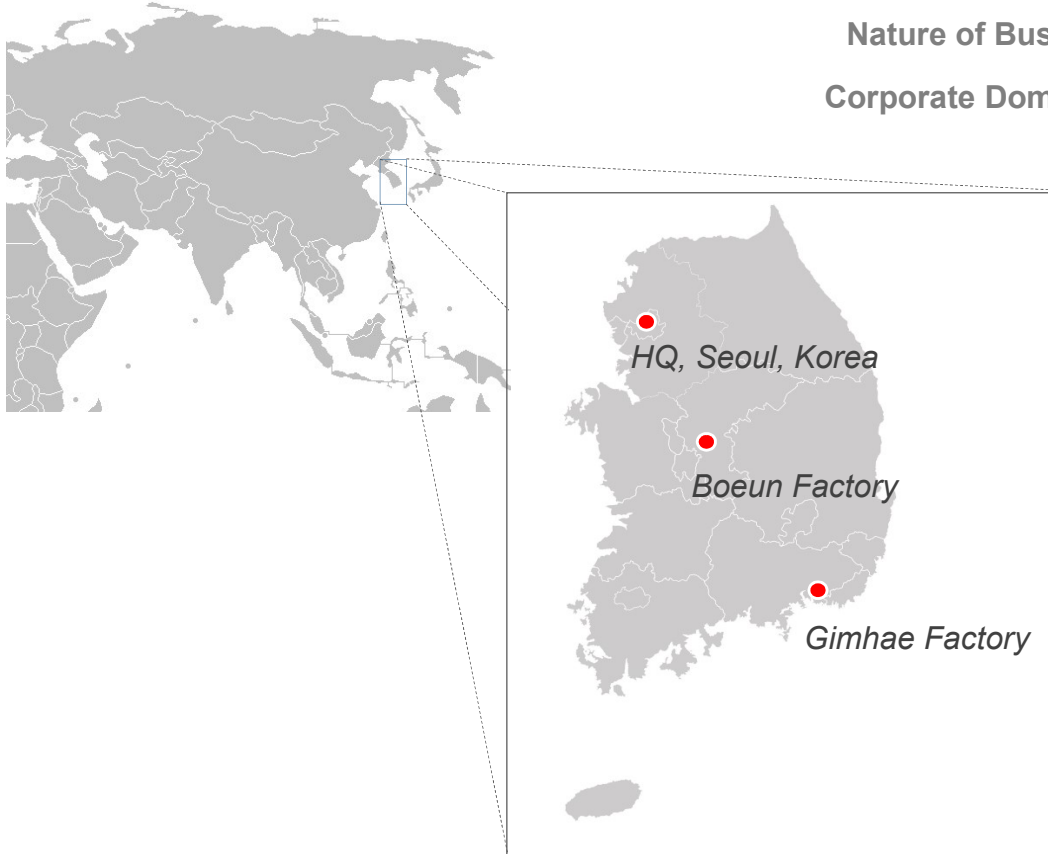

**Company Name** **Kyeam Technologies Co., Ltd.**  
**Date of Foundation** March 23, 1998  
**President** Chung, Hyun-Bong  
**Annual Turnover** USD 31.5 Million (FY2015)  
**Nature of Business** Manufacturing, Trading, and Engineering  
**Corporate Domiciles**

- **HQ**  
95 Sambong-ro, Suite 1503  
Jongno-gu, Seoul, Rep. of Korea (03150)  
Phone: +82-2-2615-1391  
Fax: +82-2-2615-1392  
URL: <http://www.kyeam.com/>  
eMail: [sales@kyeam.com](mailto:sales@kyeam.com)
- **Boeun Factory (1<sup>st</sup>)**  
3667 Bocheong-daero, Hoein-myeon, Boeun-gun  
Chungcheongbuk-do, Rep. of Korea (28927)
- **Gimhae Factory (2<sup>nd</sup>)**  
102-32, Seoburo-1499-beon-gil, Jucheon-myeon  
Gimhae-si, Gyeongsangnam-do, Rep. of Korea  
(50877)

## A MESSAGE FROM THE PRESIDENT



*“Since the inception of our business in serving EPC industries with plant piping fabrications and instruments eighteen years ago, our growth has been achieved in parallel with our efforts to meet up the expectation of our customers. In this continuum, we have consistently expanded the boundary of our business endeavour to the entire world.*

*We believe that we just made a first, but giant step. We will continue to leap our steps for customer satisfaction with quality and punctuality of our products.”*

Hyun-bong Chung,

the President of Kyeam Technologies Co., Ltd.

# CORPORATE CHRONOLOGY



The Executives and Staffs at  
Company Retreat  
in Celebration of 18<sup>th</sup> Anniversary  
of 2016

- FY1998 mar Found Kyeam Technologies Co., Ltd.
- apr Made an Agency Agreement with TLV, Inc.
- aug Made an Agency agreement with Hy-Lok Corp.
- dec Registered to Hyundai Engineering Co., Ltd. as a Supplier
- FY1999 aug Registered to Hyundai Engineering & Construction Co., Ltd. as a Supplier
- FY2000 apr Registered to Sithe Asia as a Venture Company
- FY2002 jul Registered to Samsung Electronic Co., Ltd. as a Venture Company
- FY2004 aug Registered to Lotte Petrochemical Co., Ltd. as a Venture Company
- FY2005 nov Certified ISO 9001 for Fabrication
- FY2006 jun Registered to STX Heavy Industries Co., Ltd. as a supplier
- FY2006 dec [Registered to Fuji Electric Systems Co., Ltd. as a supplier](#)
- FY2008 jan Made an Agency Agreement with O'Brien Corp. for VIPAK & TRACEPAK, USA
- FY2009 jan Made an Agency agreement with Flowserve Pte Ltd.
- feb Made an Agency agreement with Husteel Co., Ltd.
- nov "Export Achievement Award of USD 5 Mil.," the Ministry of Trade, Industry, & Energy, Korea
- FY2010 dec [Best Partner of Hyundai E&C Co., Ltd.](#)
- FY2011 dec Made an Agency agreement with PALP, Iran.
- FY2012 jun Made an Agency agreement with WIPH, Japan.
- jul Certified ISO 14001
- nov Made an Agency agreement with Tech System Ltd., Bangladesh
- nov Establish 2nd Factory in Gimhae
- FY2013 feb [Best Partner of Hyundai Engineering Co., Ltd.](#)
- aug Made an Agency Agreement with INDOREA
- dec Made an Agency agreement with Sriti, CPI in Indonesia
- FY2014 mar Made an Agency agreement with YB Valve in Taiwan
- jun Made an Agency agreement with G Wellco Industry in Ghana
- oct Made an Agency agreement with Ocean Rubber Factory in UAE
- nov Made an Agency agreement with Walsin in China
- FY2015 mar [Best Partner of Hyundai Engineering Co., Ltd.](#)
- FY2016 mar [Best Partner of Hyundai Engineering Co., Ltd.](#)



# PERFORMANCE CERTIFICATES



ISO 9001: 2008



ISO 14001: 2004



Performance Award for Accredited Vendors, Hyundai Engineering Co., Ltd.

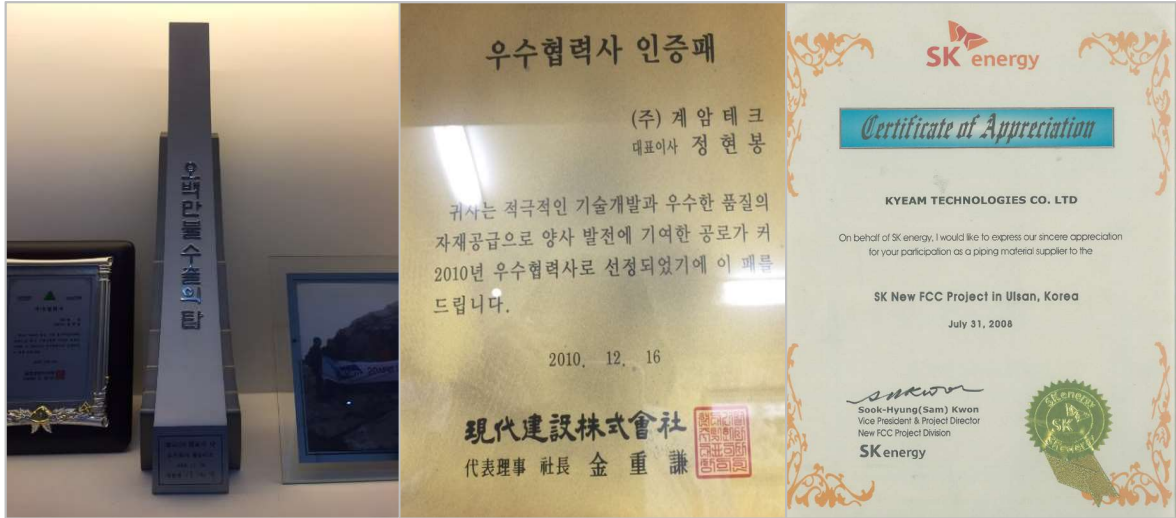

Presidential Award 2009 for Export over USD 5 Million

Performance Award for Accredited Vendors. Hyundai Engineering and Construction Co., Ltd. and SK Energy Co., Ltd.

# ORGANIZATION COMPOSITION



- 4 Departments and 9 Teams
  - Administrative
  - QA/QC
  - Marketing and Sales
    - 3 Domestic Sales Teams
    - 1 Overseas Sales Team
  - Fabrication (Factories)
    - Fabrication Support Team
    - Engineering Design Team
    - 2 Fabrication Management Teams

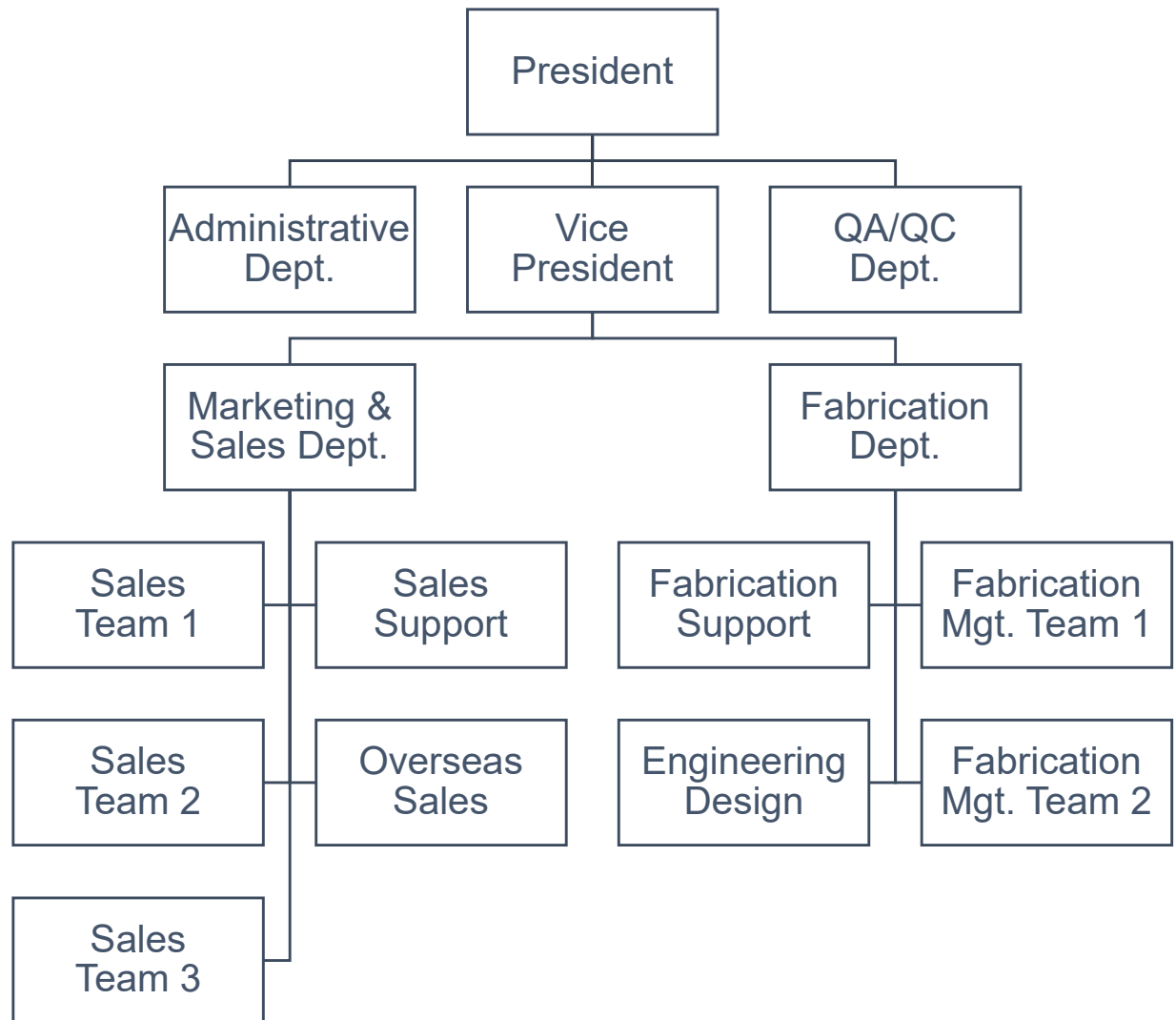



Pipe Spools

Specialty  
Products

# PRODUCT FABRICATION

**Kyeam**

Pipe Supports  
and  
Structures

Instrumentations

Rubber  
Lining



# PIPE SPOOL FABRICATION

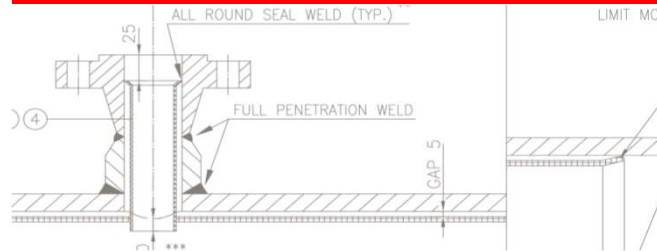

## General Pipe Spool Fabrication

- Fabrication Design
- Material Procurement & Handling (ASTM, KS, JIS, DIN)
- Machining & Welding / Bending PWHT
- NDE
- Shot Blasting / Painting



fabrication in process: LPG cutting



fabrication in process: welding



pneumatic testing



shot blasting



painting and drying



packing

# PIPE RUBBER LINING

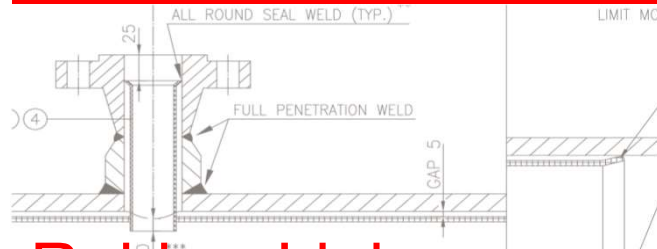

## Rubber Lining Processes

- Internal Shot-Blasting
- Internal Adhesive Application
- Rubber Lining Layer Fixation
- Curing by Autoclave Machine or Open Curing
- Testing: Pinhole, Hardness, Thickness, Adhesion
- External Shot Blasting
- External Painting and Packing

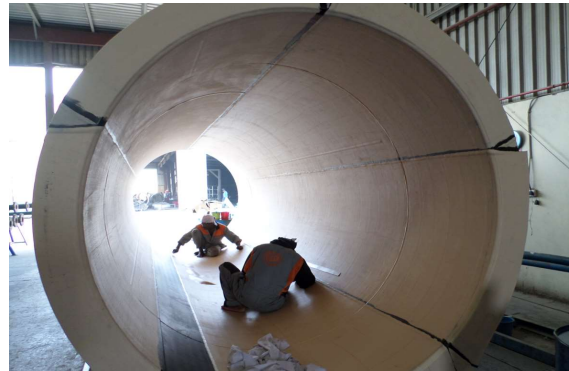

application of rubber lining layers



fixing a rubber lining tube to a small pipe



autoclave curing of rubber lined pipes



open curing of rubber lined pipes



pin-hole testing



completion of rubber lining



# PIPE SUPPORTS

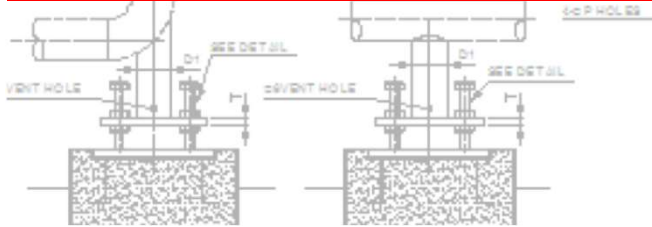

pipe support structures



cold support pads

## Support Products

- Support Structures
- Urethane(Cold) Support
- Spring Damper Supports
- Support Shoes/Pads
- Stanchions
- Clamps



spring damper supports



shoes



shoepads



stanchions

# SPECIAL PRODUCTS

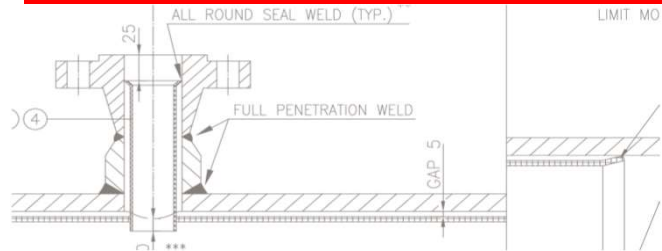

## Special by Purposes

- Steam Manifold Fabrication
- Level Bridle Skid Unit
- Customized Instrument Units



steam manifold with valves



steam manifold completed



sun shade, UV resistant (ABS/GRP)



alloy tubes for instruments



level bridle skid unit



full instrumentation unit



# SPECIAL PRODUCTS

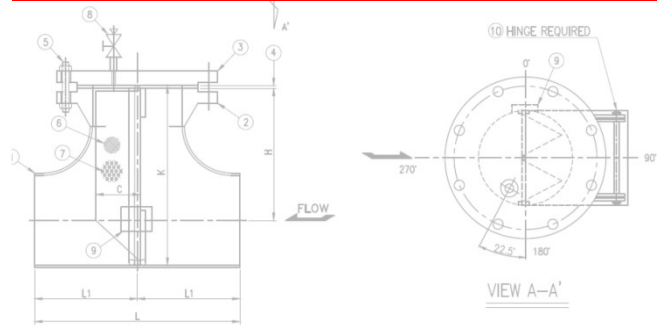

for Filtering Needs,

- Strainers: T, Y, B, Duplex Type



T-type strainers



straining units: perforated plate and meshed screen



Y-type strainer



hydro-testing: strainers



straining unit intact with strainer body



duplex type

# SPECIAL PRODUCTS

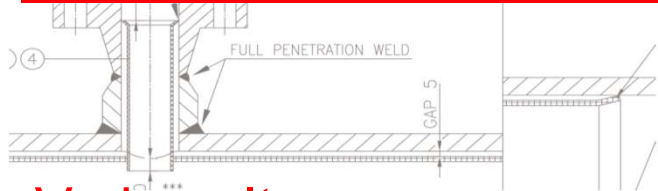

## Various Items

- Sample Cooler
- Steam Ring
- Condensate Pot
- Boiler Header
- Sample Probe
- Injection Quill
- Thermal Sleeve
- Exhaust Head

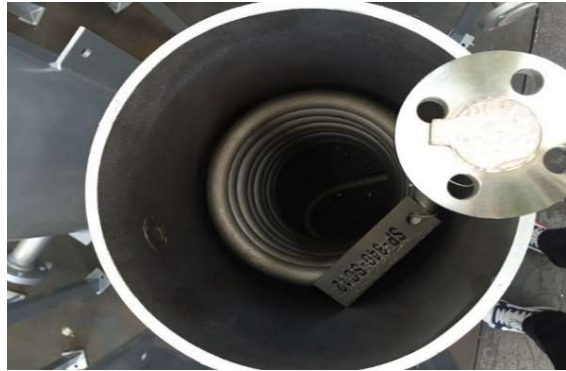

sample cooler (internal)



steam ring



lower boiler header



injection quill probe



thermal sleeve



exhaust head



# PRODUCTION CAPACITY

## • Pipe Spool: Production Capacity

Material	Capacity (per month)	
	Spool quantity (tons)	Dia. Inch
Carbon Steel	3,000	30,000
Alloy Steel	1,500	15,000
Stainless Steel	1,000	10,000

## • Pipe Supports: Production Capacity

Material	Capacity (per month)	Remarks
	Ton	
Carbon Steel	1,000	- Pipe Clamp - Hold down - Saddle - Cold Support - Embedded Metal - Anchor Frame - Shoe & Pad
Alloy Steel	700	
Stainless Steel	500	

## • Manufacturing Facility Equipment

EQUIPMENT		TYPE&MODEL	REMARK
MACHINING	MAG DRILL	WOJ-3200,220V-240V	
	MAG DRILL	WOJ-3200,220V-60Hz	
	BENCH DRILL		
	RADIAL DRILL MACHINE	DRD-1100	
WELDING MACHINE	TIG WELDER	DA 500MX	38KVA/19KW
	CO2 WELDER	PH500MX	38KVA/19KW
	ROTATOR	SK-ROT 1000A	380V * 60HZ
	ROTATOR	SK-ROT High Load	380V * 60HZ
	ROTATOR	50A-600A	380V * 60HZ
	TURNING ROLL	SK-TR 20	20,000KG
	GOUGING	NSG1500	1500A/100V
MOVING	HOIST		2.8TON
	HOIST		5TON
	HOIST		10TON
	FORKLIFT TRUCK		7TON
	FORKLIFT TRUCK		16TON
CUTTING	PLASMA CUTTING MACHINE	PERFECT 120AP	19KVA
	MEDIUM CUTTING MACHINE	SK-PGCM600	380V * 60HZ
	BAND SAW		
TESTING	DIGITAL VERNIER CALIPER	0~300mm	
	DIGITAL VERNIER CALIPER	0~600mm	
	VERNIER CALIPER	0~200mm	
	COATING THICKNESS GAUGE (CARBON STEEL)		
	COATING THICKNESS GAUGE (STAINLESS STEEL)		
	DIGITAL SURFACE PROFILE GAUGE		
	ULTRASONIC THICKNESS GAUGE	1.0~15mm	
	ULTRASONIC THICKNESS GAUGE	1.0~400mm	
	DIGITAL VERNIER CALIPER	0.01~642.60mm	
	PMI TESTER (PORTABLE)	X-MET 7000/OXFORD	
	VERNIER CALIPER	0.01~154.00mm	
	DIGITAL PSYCHROMETER		
	VERNIER CALIPER	0~300mm	



Jiuli

Pipes and  
Tubes



ACCREDITED  
AFFILIATES



Flanges



Fittings

Enclosures



Valves



# AFFILIATES' SPECIALIZATIONS



Piping Materials	Classification	Items	Manufacturer	Domain	
	Pipe		Welded Pipe	Husteel, Hyundai RB	Korea
			SMLS Pipe	Walsin	China
	Fitting		Pipe Fitting and Flange	Jiuly	China
	Valve		Forged Steel Ball Valve	KPL Valve	Korea
			Butterfly Valve	Sejin Valve	Korea
			Special Valve	Flowserve	International
			DBB Valve	Hy-Lok	Korea
		Steam Trap & Air Trap	TLV	Japan	

Instrument Materials	Classification	Items	Manufacturer	Domain	
	Valve		Control Valve	Flowserve	International
			Motor Operated Valve	Flowserve	International
			On-Off (ESD) Valve	Youngpoong	Korea
			Instrument Valve	Hy-Lok Corporation	Korea
			Instrument Valve	Hy-Lok Corporation	Korea
	Tube		Tracing Tube	Kwangshin I.S.T.	Korea
			Special Tube	Walsin Special Tube	China
	Misc.		Instrument Tube Fitting	Hy-Lok	Korea
			Sunshade	Bulk	Italy
		Enclosure Box	Bulk	Italy	



**KEY  
CLIENTELE**





# MAJOR SUPPLY RECORD 1/3

Over USD 2 Millions



PROJECT	EPC	CLIENT	SUPPLY MATERIAL	AMOUNT (US\$)	YEAR
CAFC Oil Project / CHEM	DWC	Sonatrach / Algeria	Pipe (Duplex/Bends)	15,613,000	2015~2016
UMM WU'AL PHOSPHATE / CHEM	HWC	Ma'aden Wa'ad Al-Shamal Phosphate Company / K.S.A.	Spool Fabrication Rubber Lining Piping Miscellaneous Pipe Support	22,757,000	2015~2016
Taeon TPP Unit 9, 10 / PWR	STX	Korea West Power / Korea	Spool Fabrication Rubber Lining	2,700,000	2015~2016
Bukpyung TPP Unit 1, 2 / PWR	STX	GS Donghae Electric Power / Korea	Spool Fabrication Rubber Lining	4,658,000	2015~2016
Mixed Xylene / CHEM	HDEC	Hyundai Oil Bank / Korea	Special Piping (Thermal Sleeve) Piping Miscellaneous Steam Tracing Ball Valve	2,195,000	2015~2016
Turkmenistan Ethane Cracker and PE PP Plant / CHEM	HEC	Turkmengas / Turkmenistan	Pipe Support Special Piping (Sample Cooler) Steam Tracing Instrument Miscellaneous	2,502,000	2014~2016
PTC Jubail Polysilicon Project / CHEM	KCC	Polysilicon Technology Company / K.S.A.	Pipe Support Instrument Miscellaneous Strainer	2,422,000	2013
Ma'aden Alumina Refinery / CHEM	HDEC	MBAC / K.S.A.	Piping Miscellaneous Steam Trap Instrument Miscellaneous	4,446,000	2012~2014

# MAJOR SUPPLY RECORD 2/3



PROJECT	EPC	CLIENT	SUPPLY MATERIAL	AMOUNT (US\$)	YEAR
Musandam Gas Plant / CHEM	HEC	Oman Oil company Exploration & Production LLC / Oman	Pipe Support Special Piping (Sample Cooler/Probe) Steam Tracing Instrument Miscellaneous	3,957,000	2012~2015
Group III Base Oil Production Facilities / CHEM	HEC	Abu Dhabi Oil Refining Company / U.A.E.	Spool Fabrication (Ni-Alloy Spool) Special Piping (Steam Ring) Pipe Support Steam Tracing	4,317,000	2011~2014
KOC Pipeline Part A / CHEM	HDEC	Kuwait Oil Company / Kuwait	Pipe Support Instrument Miscellaneous	4,589,000	2011~2015
Borouge 3 Utilities & Offsites / CHEM	HDEC	Abu Dhabi Polymers Co. Ltd. / U.A.E.	Pipe Support Steam Tracing Instrument Miscellaneous	3,840,000	2011~2014
Yeosu Oil Tank Terminal / CHEM	HDEC	Oilhub Korea Yeosu Co., Ltd. / Korea	Special Piping (Sleeve Pipe) Valve (Ball/Forged/DBB) Instrument Miscellaneous	3,206,000	2011~2012
MMA-2D / CHEM	HEC	Daesan MMA Corporation / Korea	Piping Miscellaneous Steam Tracing Instrument Miscellaneous Ball Valve	2,259,000	2011~2012
Habshan 5 Utilities & Offsites / CHEM	HDEC	GASCO / U.A.E.	Special Piping (Sample Cooler, Pot) Steam Trap DBB Valve Cryogenic Ball Valve Instrument Miscellaneous	5,585,000	2010~2013



# MAJOR SUPPLY RECORD 3/3



PROJECT	EPC	CLIENT	SUPPLY MATERIAL	AMOUNT (US\$)	YEAR
Turkmenistan Gas Desulfurization Plant / CHEM	HEC	Turkmengas / Turkmenistan	Spool Fabrication Special Piping (Piping Pot) Piping Miscellaneous Steam Tracing Instrument Miscellaneous Flange Forged Valve (Forged/Ball/DBB)	5,516,000	2009~2013
Karan Gas Field Development / CHEM	HDEC	Aramco / K.S.A.	Special Piping (Sample Cooler) Instrument Miscellaneous	2,719,000	2009~2012
HDO#2 HOU / CHEM	HDEC	Hyundai Oil Bank Co., Ltd. / Korea	Piping Miscellaneous Steam Tracing MOV (Ball Valve) Forged Valve	3,204,000	2009~2011
Nga Awa Purua / GPP	Fuji Elec.	Mighty River Power / New Zealand	Pressure Vessel HP/IP/LP Steam Separator HP/IP Steam Scrubber LP Steam Demister HP/IP/LP Steam Strainer Pipe Support Piping Miscellaneous Valve Instrument Miscellaneous	10,500,000	2008~2010
Nhon Trach 1 450MW CCPP / PWR	HEC	Petro Vietnam GPPMB / Vietnam	Spool Fabrication	2,800,000	2008



LEAPING  
FOR THE FUTURE  
AND  
FOR THE WORLD,

# Corporate Profile Brief

FY2016/2017



Copyright © Reserved 2016 by Kyeam Technologies Co., Ltd.